

# Installation Guide for DS937 Ceiling Mounted, Passive Infrared (PIR) Intrusion Detectors

## 1.0 Description

The DS937 is a low-profile, ceiling-mount Passive Infrared Intrusion detector that provides a 360° coverage pattern. The low profile design provides a recessed-mount look, even when surface mounted. It is easy to install with access to wiring and programming options available without removing the detector from the ceiling. With a 50 ft. (14 m) diameter coverage pattern, it is an ideal choice for applications that require ceiling mounting and spot or 360° detection.

## 2.0 Specifications

- **Input Power:** 9 to 30 VDC; 7.5 to 24 VAC.
- **Current Draw:** 17 mA maximum at 12 VDC.
- **Standby Current:** Intended for connection to DC power supplies capable of supplying power if primary power fails.
- **Coverage:** 50 detection zones.

Mounting Height	Detection Area Maximum Diameter
8 ft. (2.4 m)	38 ft. (11.6 m)
10 ft. (3.0 m)	46 ft. (14.0 m)
12 ft. (3.7 m)	50 ft. (15.2 m)

- **Detectable Speed:** 0.5 to 15 ft./s (0.2 to 5.0 m/s)
- **Alarm Contacts:** NC (Normally Closed) dry contacts, rated 500 mA, 10 W max. @ 30 VDC.
- **Tamper Switch:** NC Integral, Cover-Activated
- **Sensitivity Selection:** Field selectable for 1, 2, 3, or 4 pulse counts.
- **Storage and Operating Temperature:** +14°F to +122°F (-10°C to +50°C).
- **Humidity:** 0 to 95% non-condensing
- **Dimensions:** 5 inches diameter by 1.5 inches high (125 mm diameter x 38 mm high)

## 3.0 Avoid:

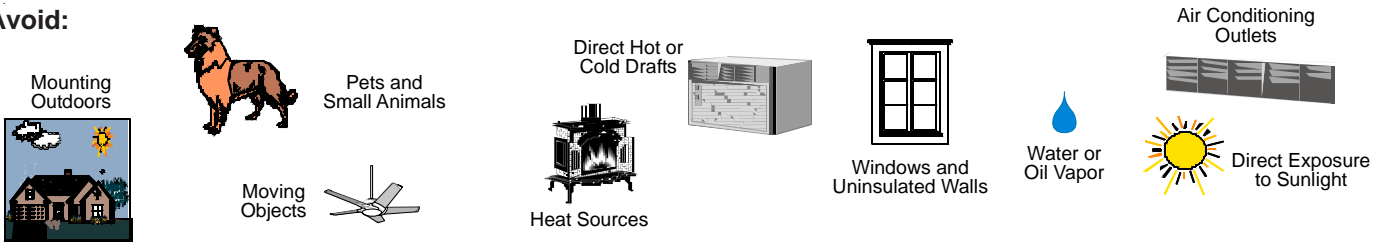

## 4.0 Mounting

**4.1 Use the mounting template** to position and drill the wiring hole and starter holes for the two mounting screws provided with the detector.

**4.2 Install the provided mounting screws** leaving enough space between the screwhead and the mounting surface to allow placement of the detector base.

### 4.3 Mount the detector base

1. Remove the Outer Cover Ring (may be pried loose with a small flatbladed screwdriver).
2. Loosen the cover screw.
3. Turn the cover dome counterclockwise and lift it off the detector.
4. Slide the detector over the mounting screws.
5. Rotate the detector clockwise until the slots firmly engage the mounting screws.
6. Tighten the mounting screws.

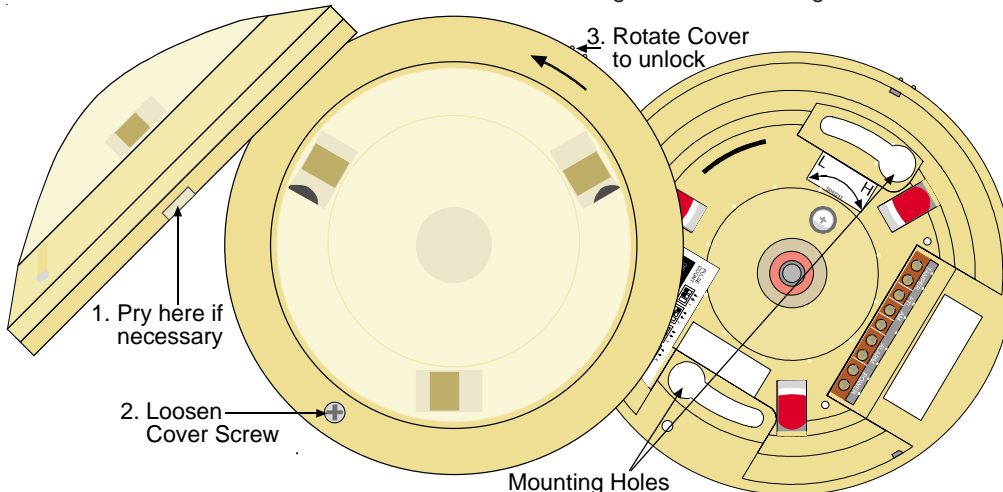

**4.4 Connect wires** to the Terminal Block by passing them through the Wiring Passage.

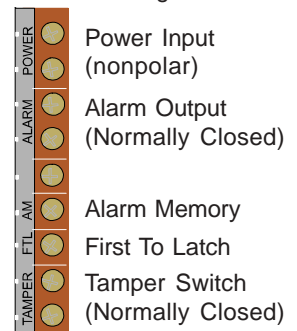

**Only apply power after all connections have been made and inspected.**

#### 4.5 Wire as shown to use the Alarm Memory and First To Latch functions.

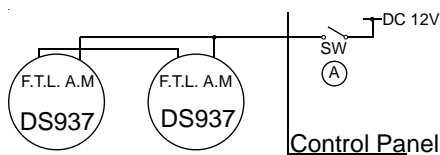

#### Notes:

1. If there is no alarm history, the DS937 operates the same as normal when switch A is opened.
2. If switch A is closed after being opened, the alarm memory will be cleared after one second.

#### Alarm Memory only:

- Wiring of First To Latch is **not** needed.
- Run a single wire from the AM terminal to switch A and then to +12 VDC.
- Switch A should stay in the closed position for normal operation.
- When alarm history is needed, open switch A. The LED of the DS937 with alarm history will flash.

#### Alarm Memory in Conjunction with First To Latch:

- First To Latch identifies the first DS937 to alarm.
- Procedure is the same as Alarm Memory function.
- When alarm history is checked, the DS937 that alarmed first will have a flashing LED.

#### 4.6 Set the LED On/Off Select Switch.

During the warm-up period, the LED flashes for about 30 seconds and the relay is kept in alarm condition.

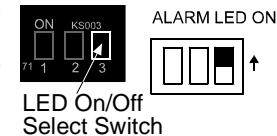

If you don't want the alarm LED to light, it can be turned off with this switch. If the LED On/Off Select Switch is in Off mode, the LED will indicate an alarm history when using Alarm Memory only or when using Alarm Memory in conjunction with First To Latch. If the LED On/Off Select Switch is in On mode, the LED will not operate in normal conditions when using the Alarm Memory and First To Latch functions.

#### 4.7 Set the Sensitivity Switch.

#### Pulse Count:

**4 pulse counts** is the recommended setting for locations where an intruder is expected to cover a sizable portion of the protection area. The detector tolerates harsh environments at this setting.

**3 pulse counts** is for locations where normal environmental transients are expected.

**2 pulse counts** is the normal setting for areas where thermal and illumination transients are minimal.

**1 pulse count** is for fast response to intruder signals. It is for use in quiet environments where thermal and illumination transients are not anticipated.

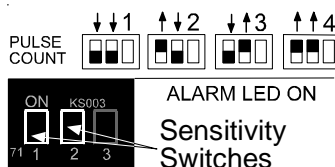

#### Detection Range Adjustment:

The Detection Range Adjustment may also be used to fine tune the sensitivity of the detector. Adjust the control for the lowest setting that provides good catch performance.

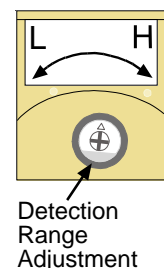

**4.8 Mask unwanted detection zones** (see 6.0 Coverage Patterns) by lifting the Lens Lock, rotating and removing the Fresnel Lens, and covering the unwanted lens areas with the masking sticker.



Clean the Fresnel Lens with a soft, clean, damp cloth. Make sure there is no dirt or fingerprints on the lens.

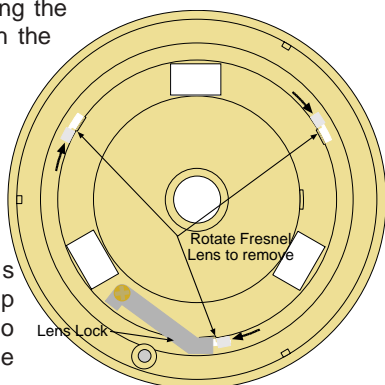

#### 4.9 Reassemble the detector.

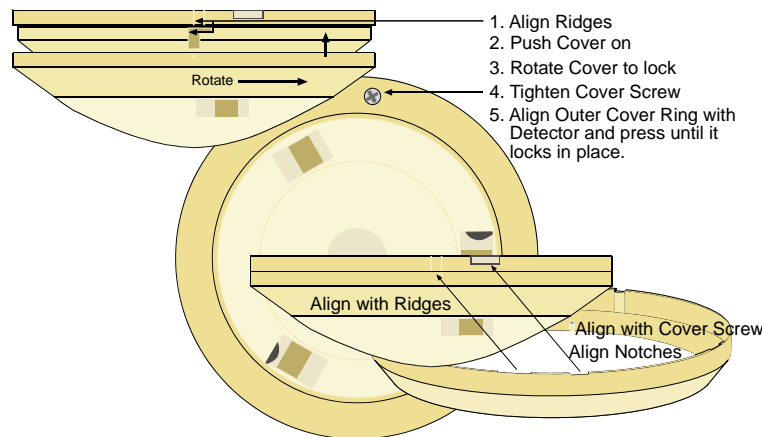

**5.0 Walk Test the detector.** Wait until the LED stops flashing after applying power to the detector to start walk tests. Observe the Alarm LED while walking across the coverage area. It will light as you enter the coverage area. Walk test from both directions to determine the exact boundaries. Adjust the detector and continue walk testing until the desired coverage pattern has been obtained.

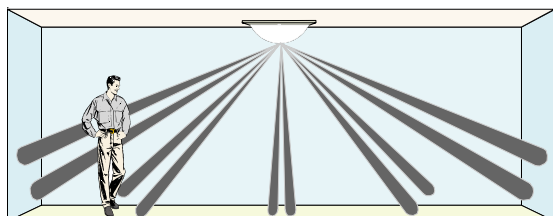

**NOTE:** Walk testing should be done across the coverage pattern.

#### 6.0 Coverage Patterns

