

Conettix C900V2



EN | Installation Guide
Dialer Capture Ethernet
Module



BOSCH

Trademarks

Altronix® is a registered trademark of Altronix Corporation.

Phillips® is a registered trademark of Phillips Screw Company in the United States and other countries.

Windows® 98, Windows® 2000, and Windows® XP, are registered trademarks of Microsoft Corporation in the United States and/or other countries.

UL Listings and Approvals

The Conettix C900V2 Dialer Capture Ethernet Module is UL Listed under the following standards:

- UL Central Station Burglary (1610), Encrypted Line Security
- UL Commercial Fire Alarm Signaling (864), Primary
- UL Police Station Burglar Alarm Units and Systems (365)
- FCC Part 15 Radiated/Conducted Emissions
- cUL S304-M88, Central and Monitoring Station Burglar Alarm Units
- C1076, Proprietary Burglar Alarm Units and Systems

cUL installations approved for Level 3 Line Security when communicating over a packet-switched data network (PSDN). Install according to ULC-S302.



Refer to the *D6200 Software Operation and Installation Guide* (P/N: 4998154991) for information on how to prepare the D6600 or D6100i in your Monitoring Center to receive UL Listed communications from a Conettix C900V2 Dialer Capture Ethernet Module.

Contents

1.0	Introduction.....	4
2.0	Installation.....	4
2.1	Mounting.....	4
2.1.1	Optional Mounting Plate.....	4
2.1.2	Attaching the Module to the Enclosure Door	5
2.1.3	Separate Enclosure Mounting.....	5
2.2	Wiring.....	6
2.3	Input Functions.....	7
2.4	Output Functions.....	7
2.5	Power Terminal Strip.....	7
2.6	Telephone Connections.....	7
2.7	Ethernet Connection.....	8
3.0	Setup.....	8
3.1	Setting P3.....	8
3.2	Setting the DIP Switches.....	8
3.3	LEDs.....	10
3.3.1	System LED (LED 1).....	10
3.3.2	Dialer LED (LED 2).....	10
3.5	Dialer Interaction.....	12
4.0	C900V2 Configuration Setup Instructions	13
4.1	Dynamic Host Configuration Protocol (DHCP)	13
4.2	Identifying the MAC Hardware Address.....	13
4.3	Getting an IP Address.....	13
4.4	Initial IP Address Assignment Using ARP.EXE	13
4.5	Using Telnet to Finish the Configuration....	14
4.5.1	Starting Windows 98SE, ME Telnet.....	14
4.5.2	Starting Windows 2000/XP Telnet.....	15
4.5.3	Configuration Using Telnet.....	16
5.0	Anti-Substitution Protection.....	18
6.0	UL Standard 1610 and ULC S304 Intrusion	19
6.1	Protected Premises Control Panel without	19
	Digital Dialer Backup.....	
6.2	Protected Premises Control Panel with Digital	22
	Dialer Backup.....	
7.0	UL Standard 864 for Fire System	23
	Installations.....	
8.0	Specifications.....	26
	Appendix : C900V2 Compatible Data Formats ...	27

Figures

Figure 1:	Location of Major Components.....	4
Figure 2:	Optional Mounting Plate.....	5
Figure 3:	Attaching to Enclosure Door.....	5
Figure 4:	C900V2 in AE2 Enclosure.....	5
Figure 5:	Wiring to a DS7400Xi in the Same	6
	Enclosure.....	
Figure 6:	C900V2 Input, Output, and Power.....	7
Figure 7:	RJ-11 Connector Wiring.....	7
Figure 8:	C900V2 DIP Switches.....	8
Figure 9:	C900V2 LED Locations.....	10
Figure 10:	MAC Address Label Example.....	13
Figure 11:	ARP Table.....	14
Figure 12:	C900V2 and Generic Control Panel in	20
	Separate Enclosures (UL Standard 1610,	
	with or without Telephone Line).....	
Figure 13:	C900V2 and Generic Control Panel in	24
	Separate Enclosures (UL Standard 864)	
	

Tables

Table 1:	Power Terminal Functions.....	7
Table 2:	Control Panel and PSTN RJ-45	7
	Connectors.....	
Table 3:	Ethernet Connector Pins.....	8
Table 4:	Digital Dialer Protocol (DIP Switches 1	9
	through 4, and 10).....	
Table 5:	DIP Switches 5 through 9.....	10
Table 6:	System LED Functions.....	11
Table 7:	Dialer LED Functions.....	11
Table 8:	Dialer Interaction Forcing C900V2 into	12
	Fallback Mode.....	
Table 9:	Netmask Address.....	16
Table 10:	Connection Sequence – C900V2 and	21
	Generic Control Panel in Separate	
	Enclosures (UL Standard 1610, with or	
	without Telephone Line).....	
Table 11:	Connection Sequence – C900V2 and	25
	Generic Control Panel in Separate	
	Enclosures (UL Standard 864).....	
Table 12:	Specifications.....	26
Table 13:	Compatible Central Station Receiver	27
	Formats.....	

1.0 Introduction

The Conettix C900V2 Dialer Capture Ethernet Module (referred to as the C900V2) links the digital dialer (data output) from a control panel to an Ethernet connection on a local area network (LAN) or wide area network (WAN).

When the dialer sends a message, the C900V2 simulates a public switched telephone network (PSTN) connection to the central station. The C900V2 decodes the digital dialer message and sends the decoded signals by Ethernet connection to the Conettix D6600 or D6100i. Communication Gateway/Receiver (referred to as the receiver). When the receiver acknowledges receipt of the message, the C900V2 sends an acknowledge message to the dialer. This process maintains true end-to-end security.

The C900V2 has three modular connectors:

- TELCO connects to the PSTN.
- PANEL connects to a digital dialer.
- Ethernet connects to the network.

In Intercept Mode, the C900V2 connects the digital dialer to a LAN or WAN. In Fallback Mode, the C900V2 connects the dialer to the PSTN, which bypasses the C900V2 from the phone circuit. The C900V2 stays in Intercept Mode when its CPU is working (Output 1 open). In Fallback Mode, the C900V2 connects the dialer directly to the PSTN. The C900V2 switches to Fallback Mode if there is a CPU or network failure.

2.0 Installation



Failure to follow these instructions can result in the system failing to transmit an alarm. Bosch Security Systems, Inc. is not responsible for improperly installed, tested, or maintained devices.



Notify the central station and the local authority before installing the C900V2 in an existing system.

Disconnect all power to the control panel before installing the C900V2.

2.1 Mounting



The C900V2 is static sensitive. Before handling the circuit board, touch earth ground to discharge any static electricity from your body. Use a grounding strap while installing the circuit board.

Figure 1: Location of Major Components

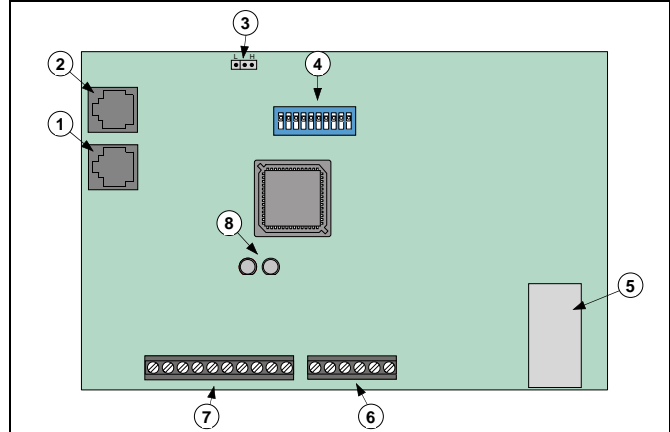

- 1 – RJ-45 phone jack (to PSTN)
- 2 – RJ-45 phone jack (to control panel)
- 3 – High and low voltage selector (refer to Section 3.1 on page 8)
- 4 – DIP switch (refer to Section 3.2 on page 8)
- 5 – RJ-45 Ethernet jack (to LAN or WAN)
- 6 – Power terminal strip (refer to Section 2.5 on page 7)
- 7 – Input and output wiring terminals (refer to Sections 2.3 and 2.4 on page 7)
- 8 – Dialer and system LEDs (refer to Section 3.3 on page 10)

2.1.1 Optional Mounting Plate

Use an optional mounting plate (P/N: 40182) for mounting the C900V2 on the door of a control panel (D8103) or a fire control panel enclosure (D8109). You cannot use the D8108A Attack Resistant Enclosure.



Mounting a C900V2 in a control panel enclosure is approved by UL only when used with a DS7400Xi as shown in Figure 5 on page 6.

For the following procedure, refer to Figure 2 on page 5.

1. Insert the top hook of the supplied top (1) and bottom plastic standoffs (2) into the mounting plate brackets (3). Refer to Detail A.
2. Align the holes in the mounting brackets (3) and the plastic standoffs (1 and 2).

Figure 2: Optional Mounting Plate

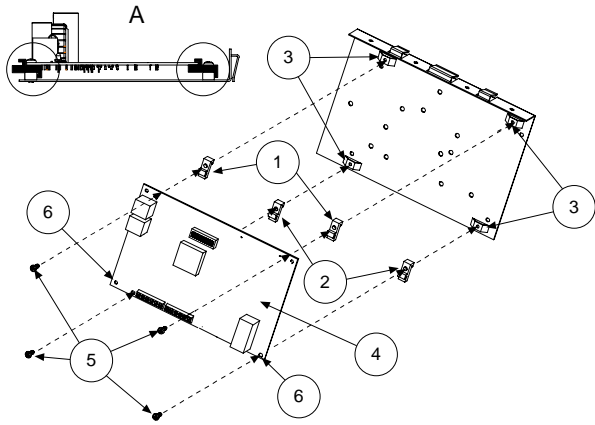

3. Place the top edge of the C900V2 (4) under the standoff bracket of the top two standoffs (1).
4. Insert two of the Phillips® head screws provided (5) through the holes in the top standoffs (3).
5. Lower the bottom edge of the module to rest against the ledge of the two bottom standoffs (2).
6. Insert the other two Phillips head screws (5) into the bottom two mounting holes (6) on the C900V2 and through the bottom two plastic standoffs (2) and mounting bracket (3).
7. Tighten the screws until the C900V2 is attached securely to the mounting plate.

2.1.2 Attaching the Module to the Enclosure Door

Refer to Figure 3.

Figure 3: Attaching to Enclosure Door

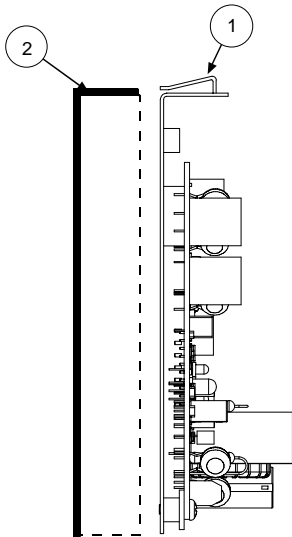

1. Slide the tabs (1) at the top of the mounting plate over the top lip of the enclosure door (2).
2. Position the mounting plate on the side farthest from the door hinge.

2.1.3 Separate Enclosure Mounting

You can mount the C900V2 in a separate enclosure such as the AE2. Refer to Figure 4.



Mount the enclosure on a vertical surface before you install the C900V2 because the C900V2 covers one of the mounting holes (9).

1. Place the top edge of the C900V2 (1) between the two slots (2) on the inside top of the enclosure (3).
2. Insert the top hook of the top plastic standoffs (4) into the mounting brackets (5) on the back wall of the enclosure (6), showing a side view of the standoff in the mounting bracket).
3. Align the bottom two mounting holes (7) on the C900V2 with the plastic standoffs (4) and the enclosure mounting brackets (5).
4. Insert two screws (8) into the holes and slowly tighten until the C900V2 is secured firmly to the enclosure.

Figure 4: C900V2 in AE2 Enclosure

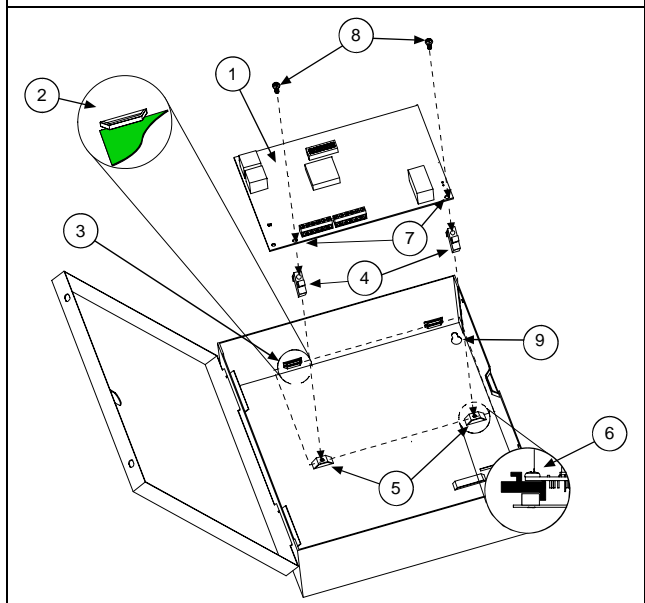

2.2 Wiring

Figure 5: Wiring to a DS7400Xi in the Same Enclosure

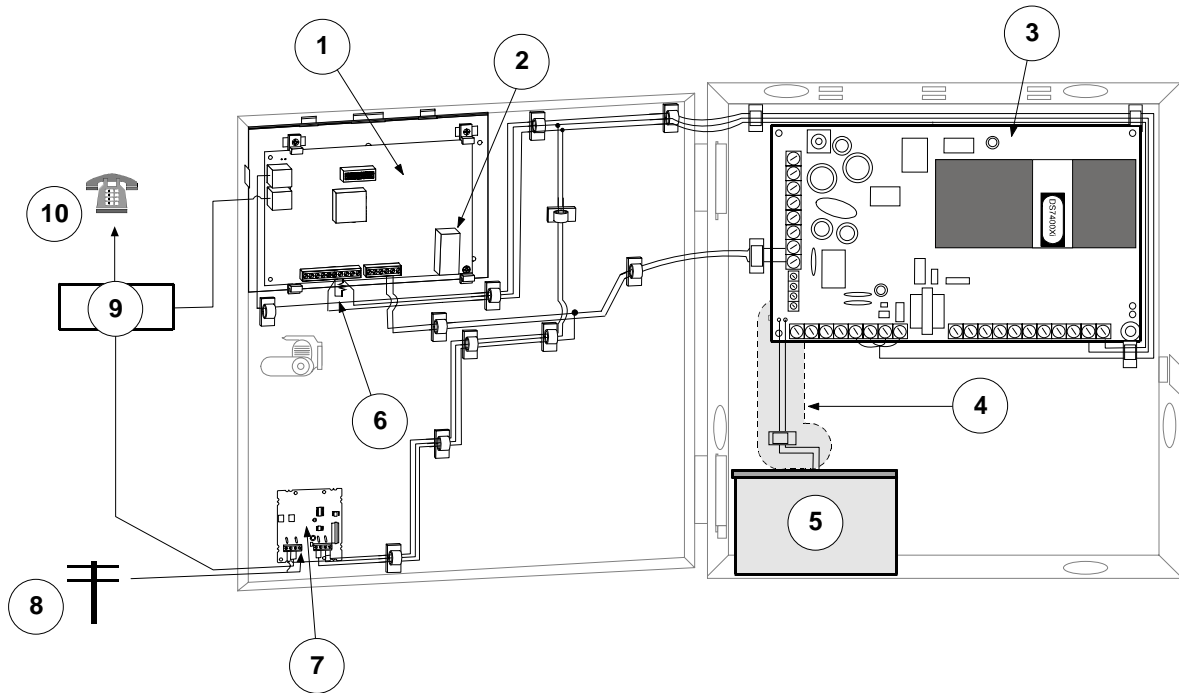

1 – C900V2

2 – To LAN or WAN port

3 – DS7400Xi Control Panel

4 – Non-power limited area

NOTE: All power limited wiring must be at least 6.4 mm (0.25 in.) from the battery wiring.

5 – Battery

6 – EOL resistor for the control panel, attached to terminals

7 – DS7481 Single Phone Line Monitor (optional)

8 – Telco jack

9 – RJ31X

10 – House telephone

You can use the C900V2 with a variety of control panels. The next sections provide information for wiring the C900V2 to a generic control panel. Refer to *Figure 5*.



The control panel's phone line monitor becomes inactive when the C900V2 intercepts the phone line between the telco service and the control panel. If phone line monitoring is required, use an external phone line monitor, such as the Bosch Security Systems, Inc. DS7481.

The loss of a network connection closes the Output 2 relay contact on the C900V2. You can connect this output to a 24-hour zone on the control panel.



The DS7400Xi is the only control panel approved by UL to be wired in the same enclosure as the C900V2. You must install any other control panel in a separate enclosure to receive the UL approval.

2.3 Input Functions

The C900V2 has three inputs monitored by analog-to-digital (A/D) converters:

- **Input 1 (IN1):** Used as an end-of-line (EOL) supervised loop. If input status reports are enabled by the receiver using the Conettix D6200 Programming/Administration Software (referred to as D6200 Software), any voltage below 1.66 VDC is sent as a short-circuit message to the D6600. Any voltage above 3.33 VDC is sent as an open-circuit message. Input 1 must be EOL-terminated with a 10 k Ω resistor. Refer to the *D6600/D6100i Computer Interface Manual* (P/N: 4998122703) for Event Messages to automation software.
- **Input 2 (IN2):** Used for Intercept Inhibit. If Input 2 rises above 5.5 VDC, the C900V2 is immediately forced into Fallback Mode for at least 2 minutes. Input 2 must go low for at least 5 seconds to be considered low. If Input 2 is not used, allow it to remain disconnected.
- **Input 3 (IN3):** Used for Intercept Override. If Input 3 rises above 5.5 VDC for 5 seconds, the C900V2 enters Fallback Mode. If Input 3 goes low, the C900V2 returns to Intercept Mode. If this input is connected to a ground start relay output, the C900V2 remains in Intercept Mode, except to allow the dialer to dial. Input 3 cannot force Intercept Mode if the C900V2 is in Fallback Mode because of an error, a command, or a high signal at Input 2. If this input is not used, allow it to remain disconnected.



You cannot use Inputs 1, 2 and 3 for UL Fire Listing. You can use the inputs for other purposes.

Figure 6: C900V2 Input, Output, and Power

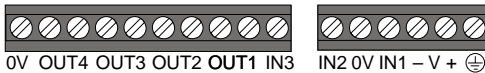

2.4 Output Functions

The C900V2 has four relay contact outputs:

- **Output 1 (OUT1):** Active (open) when the CPU works properly. If the CPU fails or loses power, Output 1 closes.
Connect Output 1 from the C900V2 to a 24-hour zone on the control panel. This 24-Hour Zone Alarm report enables the digital dialer, if used, to indicate or sound a failure if the C900V2 CPU fails.

- **Output 2 (OUT2):** Active (open) when the receiver works properly, and closed when the receiver does not respond to or acknowledge a message sent from the C900V2.

Connect Output 2 from the C900V2 to a 24-hour zone on the control panel. This 24-Hour Zone Alarm Report enables the digital dialer, if used, to indicate or sound a failure if the network communications path fails.

- **Output 3 (OUT3):** Active (open) when the C900V2 is in Intercept Mode.
- **Output 4 (OUT4):** Controlled by a command from the D6200 Software or receiver. The default is open.

2.5 Power Terminal Strip

Table 1: Power Terminal Functions

Terminal	Description
V (+)	Connect regulated 12 to 24 VDC power to this terminal and the - V terminal. This power can be supplied by a separate power supply or auxiliary power from the control panel.
V (-)	12 to 24 VDC return.
	Connect to earth ground.

2.6 Telephone Connections

Use two of the RJ-45 telephone connectors to connect to the control panel and to the PSTN. The connector pins are identified in *Table 2* and *Figure 7*.

Table 2: Control Panel and PSTN RJ-45 Connectors

Pin	Connection
1	T1
4	T
5	R
8	R1

Figure 7: RJ-11 Connector Wiring

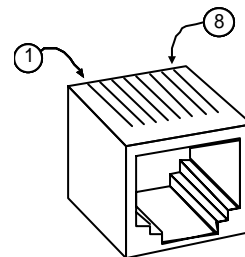

2.7 Ethernet Connection

One of the RJ-45 jacks connects the C900V2 to the Ethernet Network (LAN or WAN).

The connector pins are listed in *Table 3*.

Pin	Connection
1	TX+
2	TX-
3	RX+
6	RX-

3.0 Setup

3.1 Setting P3

A shorting link on P3 selects the voltage and current applied to the alarm panel’s telephone circuit to simulate the signal from a PSTN telephone exchange. For most alarm panels, set the shorting link to the H position (short the middle and right pins of P3). The L position results in slightly lower power consumption for the C900V2 but some alarm panels might report a telephone line failure when dialing the C900V2.



For UL approved applications, the shorting link must be set to the H position.

3.2 Setting the DIP Switches

A ten-position DIP switch programs the C900V2. The programming depends on the application and dialer format of the control panel connected to the module.

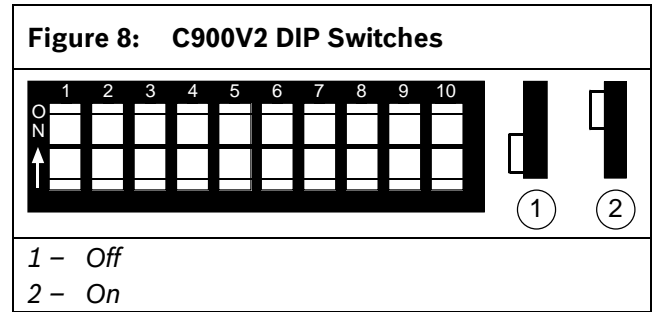

Because the C900V2 emulates a phone line and a digital receiver, you must program the C900V2 to the format it receives from the control panel.

DIP Switch positions 1 through 4 and 10 program the dialer format into the C900V2. *Table 4* on page 9 lists the format programming for these DIP switches.

Table 4: Digital Dialer Protocol (DIP Switches 1 through 4, and 10)

DIP Switches					Dialer Format of Host Alarm Panel
10	1	2	3	4	
ON	OFF	OFF	OFF	OFF	Radionics Modem IIe and Modem IIIa ²
ON	OFF	OFF	OFF	ON	Radionics Modem II
ON	OFF	OFF	ON	OFF	DTMF*
ON	OFF	OFF	ON	ON	DTMF* (where dialer retransmits quickly)
ON	OFF	ON	OFF	OFF	BFSK (2300Hz ACK Tone)
ON	OFF	ON	OFF	ON	BFSK (1400Hz ACK Tone)
ON	OFF	ON	ON	OFF	FBI Superfast DTMF (2300 Hz ACK Tone) †
ON	OFF	ON	ON	ON	FBI Superfast DTMF (1400 Hz ACK Tone) †
ON	ON	OFF	OFF	OFF	Pulse 3/1, 3/1 Checksum (2300 Hz ACK Tone)
ON	ON	OFF	OFF	ON	Pulse 3/1, 3/1 Checksum (1400 Hz ACK Tone)
ON	ON	OFF	ON	OFF	Pulse 4/2 (Long 2300 Hz ACK Tone)
ON	ON	OFF	ON	ON	Pulse 4/2 (Long 1400 Hz ACK Tone)
ON	ON	ON	OFF	OFF	SIA Bell 103 (110/300 baud, 2016 Hz ACK Tone)
ON	ON	ON	OFF	ON	Reserved
ON	ON	ON	ON	OFF	ADT-SIA†
ON	ON	ON	ON	ON	Reserved
OFF	OFF	OFF	OFF	OFF	Reserved
OFF	OFF	OFF	OFF	ON	Reserved
OFF	OFF	OFF	ON	OFF	Scancom 481, 581, 681 †, ‡
OFF	OFF	OFF	ON	ON	Reserved
OFF	OFF	ON	OFF	OFF	Reserved
OFF	OFF	ON	OFF	ON	Reserved
OFF	OFF	ON	ON	OFF	Telim †
OFF	OFF	ON	ON	ON	Robofon †
OFF	ON	OFF	OFF	OFF	Reserved
OFF	ON	OFF	OFF	ON	Reserved
OFF	ON	OFF	ON	OFF	Reserved
OFF	ON	OFF	ON	ON	Reserved
OFF	ON	ON	OFF	OFF	SIA Bell 103 (110/300 baud, 2083 Hz ACK Tone) †
OFF	ON	ON	OFF	ON	SIA V.21 (110/300 baud) †
OFF	ON	ON	ON	OFF	Series DTMF †
OFF	ON	ON	ON	ON	Series FSK †

* DTMF includes Contact ID, High Speed and 4/2 Express

† These formats have not been approved for UL 1610.

‡ Requires firmware version 1.12 or higher.

Table 5: DIP Switches 5 through 9

Switch	State	Function
5	ON	Enable auto Fallback Mode after detecting an intercept error. ¹
	OFF	Disable auto Fallback Mode after detecting an intercept error.
6	ON	Hang-ups do not cause Fallback Mode.
	OFF	Third hang-up without receiver ACK causes Fallback Mode. ²
7 ³	ON	240 sec poll
	OFF	75 sec poll
8	ON	C900 sends initial handshake to panel after 6 sec dialing break.
	OFF	C900 sends initial handshake to panel after 1 sec dialing break.
9	ON	Enable Anti-Replay/Substitution. ⁴
	OFF	Disable Anti-Replay/Substitution.

¹ If an error occurs in the Intercept Mode, the C900V2 automatically returns (falls back) to the telco line.

² If the receiver does not acknowledge a report intercepted by the C900V2 in the specified time, the digital dialer hangs up and retries the message transmission. The C900V2 switches to Fallback Mode based on the number of hang-ups.

³ The time that elapses between polls from the C900V2 when it is idle (not expecting a dialer acknowledgement).

⁴ This DIP switch must be set to ON if the receiver is set up for NNC Mode.



Any error forces the C900V2 to switch to Fallback Mode (phone line backup) for 2 min the next time the control panel seizes the line (if DIP Switch 5 is ON, DIP Switch 6 is OFF, or both, and if the control panel seizes the line within 2 min). Intercept errors are always reported to the receiver. If the receiver does not acknowledge a signal intercepted by the C900V2 in the specified time, the control panel digital dialer hangs up and tries to send the message again.

3.3 LEDs

The C900V2 has two dual-color status LEDs: the system LED and the dialer LED.

The Ethernet connector also includes two LEDs that indicate the status of the network connection. The right LED lights or flashes when there is a valid connection to the network.

3.3.1 System LED (LED 1)

The system LED indicates the status of the receiver and the C900V2 itself. Refer to **Table 6** on page 11.

3.3.2 Dialer LED (LED 2)

The dialer LED indicates the status of the digital dialer interface. Refer to **Table 7** on page 11.

Figure 9: C900V2 LED Locations

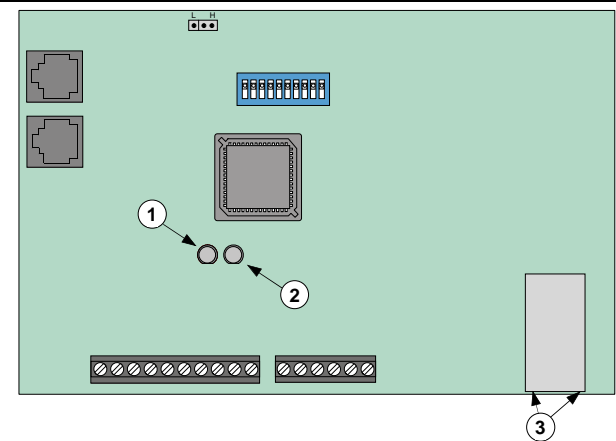

- 1 – System LED
- 2 – Dialer LED
- 3 – Ethernet connector LEDs

Table 6: System LED Functions

Color	State	Function
None	Off	No power.
Green	Solid	C900V2 failed.
	Flashing (5 Hz)	The receiver is responding normally.
Red	Solid	C900V2 failed.
	Flashing (5 Hz)	The receiver is not responding.
	Flashing (Repeating Code)	1 flash: ROM checksum error 2 flashes: RAM test error
Red/ Green	Alternating (5 Hz)	The dialer is off-hook, but the last message was rejected because of a bad checksum or other logical error. ¹

¹ If the dialer subsequently sends a valid message, the LED returns to a blinking green status. If the dialer hangs up, an intercept error is generated. The alternating LED also occurs when the line is seized, but no transaction occurs (for example, the C900V2 is waiting for the dialer to return on-hook). This happens when the C900V2 returns to Intercept Mode, or while the dialer seizes the line.

Table 7: Dialer LED Functions

Color	State	Function
None	Off	C900V2 is in permanent Fallback Mode due to a command or no power.
Green	Solid	C900V2 is in Intercept Mode and the dialer is on-hook.
	Flashing (5 Hz)	C900V2 is in Intercept Mode and the dialer is off-hook.
Red	Solid	C900V2 is in Fallback Mode due to an error, Intercept Inhibit or Override inputs, or a command.
	Flashing (5 Hz)	An off-hook condition caused an intercept error. ¹
Red/ Green	Alternating (5 Hz)	The dialer is off-hook, but the last message was rejected due to a bad checksum or other logical error. ²

¹ If Auto Fallback After Error is enabled (DIP Switch 5 = ON), the C900V2 connects the dialer to the phone line at the next line seizure. If the dialer does not seize the line, this condition terminates after two min.

² If the dialer subsequently sends a valid message, the LED returns to a blinking green status. If the dialer hangs up, an intercept error is generated. The alternating LED also occurs when the line is seized, but no transaction occurs (for example, the C900V2 is waiting for the dialer to return on-hook). This happens when the C900V2 returns to Intercept Mode, or while the dialer seizes the line.

3.4 Fallback Mode

In fallback operation, the C900V2 connects the PSTN directly to the dialer, bypassing itself from the phone circuit. Intercept Mode is maintained only if the C900V2 processor operates and there are no errors. Fallback Mode is ensured if a CPU lockup occurs.

3.5 Dialer Interaction

Table 8 shows the conditions causing the C900V2 to change to Fallback Mode. The C900V2 returns to Intercept Mode only when all conditions in the Intercept Mode Restored column are met.

Table 8: Dialer Interaction Forcing C900V2 into Fallback Mode		
Condition	Fallback Mode Occurs	Intercept Mode Restored
CPU fails	Immediately	C900V2 restart
Receiver fails	Immediately	Link restored
Receiver does not respond to last message	Dialer goes off-hook (disconnected)	Link restored
Intercept Disable Command	On receipt of the command	Intercept Enable command
Intercept Error	If Fallback after intercept error is enabled, the dialer goes off-hook within two minutes of the error	After two minutes
Switch to Fallback command	On receipt	One hour or at receipt of Intercept Enable command

4.0 C900V2 Configuration Setup Instructions

4.1 Dynamic Host Configuration Protocol (DHCP)

The receiver can communicate with a C900V2 that has an IP address dynamically assigned by a DHCP server on the network. When using DHCP, you must set the receiver to use the network naming convention (NNC) to identify accounts instead of using static IP addresses. Devices in the field can have either a static IP address or a dynamic IP address. The receiver uses the NNC number to identify the account instead of the IP address.

For devices having IP addresses assigned by a DHCP server:

- Set DIP Switch 9 on the C900V2 to ON.
- Enable NNC on the receiver. Refer to the *D6600/D6100i Computer Interface Manual* (P/N: 4998122702).
- Set the Account Database in the D6200 Software to NNC Mode. Refer to the *D6200 Programming Software Operation and Installation Guide* (P/N: 4998154991).
- Use the D6200 Software to enter the eight-digit NNC number located on the label of the C900V2 into the Account Database.. Refer to the *D6200 Programming Software Operation and Installation Guide* (P/N: 4998154991).
- Configure network connections to communicate through a DHCP server.
- Set the IP address of the C900V2 to 0.0.0.0.

4.2 Identifying the MAC Hardware Address



If you know the IP address of the configured C900V2, go to *Section 4.5 Using Telnet to Finish the Configuration* on page 14.

You must program the IP address of the C900V2. The first step is to determine the MAC, or hardware, address of the C900V2. This address is hard-coded into the C900V2 during its manufacture and cannot be changed. This address is 6 bytes (12 digits) long.

Figure 10 shows an example of a MAC address.

Figure 10: MAC Address Label Example

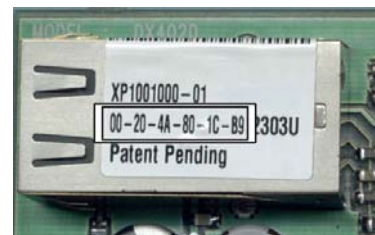

The MAC address label is located on the top of the Ethernet connector.

Record this number for future reference.

4.3 Getting an IP Address



If you are using Dynamic Host Configuration Protocol (DHCP), you do not need an IP address.

If you are not using DHCP, request an IP address for your C900V2 from your network administrator. You might have to provide the MAC address.

An IP address is an identifier for a computer or device on a TCP/IP network. The IP address is a 32-bit numeric address written as four numbers separated by periods. Each number can be zero to 255, for example, 190.200.128.111. In an isolated network, you can assign IP addresses at random if each one is unique. Connecting a private network to the Internet requires registered IP addresses (called Internet addresses) to avoid duplication.

4.4 Initial IP Address Assignment Using ARP.EXE

The C900V2 you are configuring and the PC used to configure it must both be on the same gateway (the device that connects the LAN to the WAN) to use telnet for configuration of the C900V2. The gateway can be a router or a hub. After you configure the C900V2 and assign it an IP address, you can then use telnet to change configuration parameters from anywhere on the network.



Read this entire procedure before starting. Ensure that power is applied to the C900V2 and the C900V2 is connected to the LAN or WAN through the Ethernet connector.

The following procedure shows how to use the ARP command to assign an IP address to the C900V2.



The IP and MAC addresses in this procedure are examples and are not the same as those for your C900V2.

1. Select **Start → Run**.
The **Run** dialog box appears.
2. In the **Run** dialog box, type COMMAND and click **OK**.
A DOS window appears:



3. At the DOS command line, type:
arp -s xxx.xxx.xxx.xxx zz-zz-zz-zz-zz-zz
and press [ENTER].



- xxx.xxx.xxx.xxx is the IP address the network administrator assigned to the C900V2
- zz-zz-zz-zz-zz-zz is the MAC address printed on the Ethernet connector label.

For example:

```
C:\WINDOWS>arp -s 172.17.10.70 00-20-4a-12-04-0e.
```

The program responds with a prompt to indicate that the address was accepted.

```
C:\WINDOWS>arp -s 172.17.10.70 00-20-4a-12-04-0e.  
C:\WINDOWS>_
```



The program does not indicate that the operation was performed properly. The only indication is the absence of an error message.

4. Verify that you entered the IP address correctly. Type:
arp -g
and press [ENTER].

This command displays the IP address 172.17.10.70 temporarily linked to MAC address 00-20-4a-12-04-0e as shown in *Figure 11*. The temporary link shows a static entry.

Figure 11: ARP Table

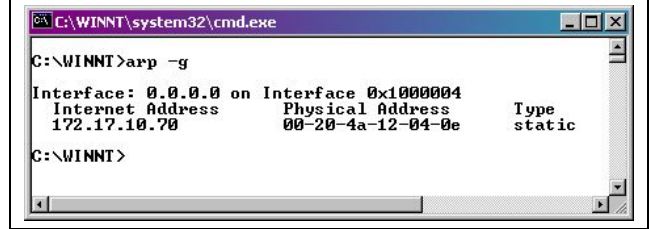

The network uses this table to identify devices and to route signals. The number of devices and other types (static and dynamic, as shown in the example) depends on the network and the number and type of devices with which this PC communicates. Identify the MAC address of the device you are installing and verify that it now has an IP address linked to it.

4.5 Using Telnet to Finish the Configuration

Use the telnet program to configure the C900V2. The procedure for Windows 98SE, ME is different from the procedure for Windows 2000 and Windows XP.

4.5.1 Starting Windows 98SE, ME Telnet

1. Select **Start → Run**.
The **Run** dialog box appears.
2. In the **Run** dialog box, type telnet and press [ENTER].
The **Telnet** application window appears.



3. Select **Connect → Remote System**.
The **Connect** dialog box appears.

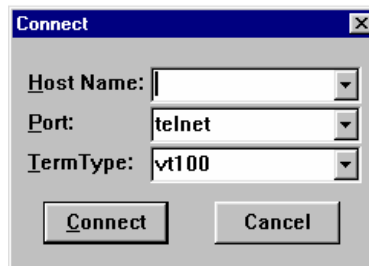

- a. In the **Host Name** field, type the IP address of the C900V2.
- b. In the **Port**, field type 1.
- c. Accept vt100 as the **TermType** field.
- d. Click **Connect**.

After a few seconds, an error message appears.

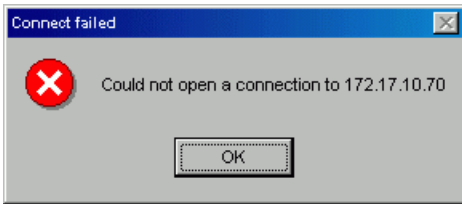

4. Click **OK** to clear the message. The **Telnet** window appears again.
5. Select **Connect → Remote System**. The **Connect** dialog box appears again.

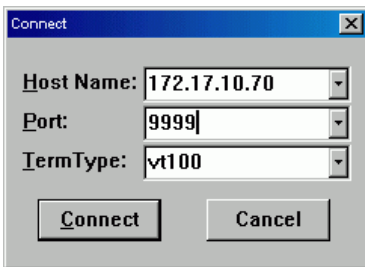

6. This time, change the **Port** field to 9999, accept the other fields, and click **Connect**. This message appears.



7. Press [ENTER].

You must press [ENTER] within five seconds or the telnet session disconnects.

The **Telnet** window shows this information.

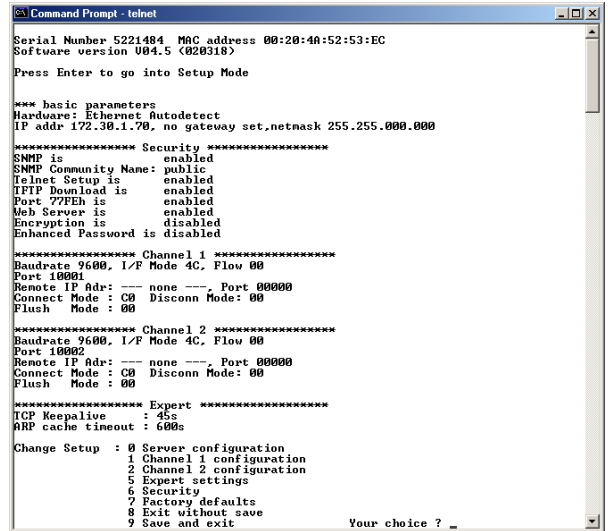

Continue with *Section 4.5.3 Configuration Using Telnet* on page 16.

4.5.2 Starting Windows 2000/XP Telnet

To do this procedure, you must log in at an administrator privilege level.

The MAC address, IP address, gateway IP address, and port number in this procedure are examples and are not the same as those for your C900V2.

1. Select **Start → Run**. The **Run** dialog box appears.
2. In the **Run** dialog box, type telnet and click **OK**. The **Telnet** window appears.

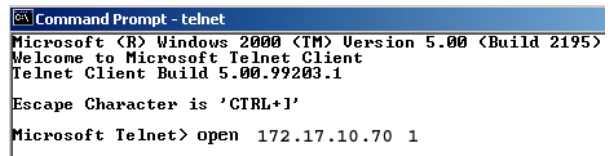

3. Type open <IP ADDRESS> 1 and press [ENTER] (where <IP ADDRESS> is the IP address of the C900V2). Type a space after open and after the IP address. For example: open 172.17.10.70 1.

The connection fails the first time. This is normal.

Repeat the previous step using 9999 as the port number:

4. Type open <IP ADDRESS> 9999 and press [ENTER] (for example, open 172.17.10.70 9999).

- Press [ENTER]. The Setup Mode information appears.

```

Command Prompt - telnet
Lantronix UTS Snr 1281-167 U3.6
Press Enter to go into Setup Mode

*** basic parameters
Hardware: Ethernet Autodetect
IP addr 172.17.10.70 no gateway set,netmask 255.255.000.000

***** Channel 1 *****
Baudrate 09600, I/F Mode 4C, Flow 00
Port 03001

Connect Mode: C0 Disconn Mode: 01
Flush Mode: 00

Change Setup : 0 Server configuration
               1 Channel 1 configuration
               7 factory defaults
               8 exit without save
               9 save and exit
Your choice ?
    
```

Continue with *Section 4.5.3 Configuration Using Telnet*.

4.5.3 Configuration Using Telnet

- Type 0 (zero) and press [ENTER] to set up the basic server configuration.
If the C900V2 was previously programmed with an IP address, the address appears in parentheses.
- Type the IP address (for example, 190.200.128.219) and press [ENTER].



If you are using DHCP type 0.0.0.0 and press [ENTER]. Refer to *Section 4.1 Dynamic Host Configuration Protocol (DHCP)* on page 13.

- If the Gateway address is required, type y, press [ENTER] and then type the address and press [ENTER].

If the Gateway address is not required or if you use DHCP, type n and press [ENTER]

This prompt appears.

Netmask: Number of Bits for Host Part (0=default) (00)



The Gateway IP is required only if you are connecting to a WAN. In a LAN, the Gateway IP is usually not needed unless the Gateway IP of the PC is different from the Gateway to which the C900V2 is connected.

- If using DHCP, press [ENTER].
If not, enter the number of bits that correspond to the netmask your network uses and press [ENTER]. Refer to *Table 9*.

Contact your network administrator if you need more information about the netmask.

Host Bits	Netmask	Host Bits	Netmask
1	255.255.255.254	17	255.254.0.0
2	255.255.255.252	18	255.252.0.0
3	255.255.255.248	18	255.248.0.0
4	255.255.255.240	20	255.240.0.0
5	255.255.255.224	21	255.224.0.0
6	255.255.255.192	22	255.192.0.0
7	255.255.255.128	23	255.128.0.0
8	255.255.255.0	24	255.0.0.0
9	255.255.254.0	25	254.0.0.0
10	255.255.252.0	26	252.0.0.0
11	255.255.248.0	27	248.0.0.0
12	255.255.240.0	28	240.0.0.0
13	255.255.224.0	29	224.0.0.0
14	255.255.192.0	30	192.0.0.0
15	255.255.128.0	31	128.0.0.0
16	255.255.0.0		

If you are using DHCP, this prompt appears.

Change DHCP device name <?><N> _

- If you do not want to assign or change the name, press [ENTER].

If you want to assign a name for this device for use on a LAN, type y and press [ENTER]. Type the name, up to 16 characters, and press [ENTER].



If you do not enter a DHCP device name, a default name of Cxxxxxx is used (where xxxxxx is the last six digits of the MAC address).

This prompt appears.

Change telnet config password <N> _

- Press [ENTER] to accept the password setting at none.



In most cases, do not assign a password. If a password is necessary, store it in a safe place. If you lose or forget the password, you cannot connect to C900V2 using telnet until you send the unit to the factory for password removal, and the unit is returned to you.

The Setup Mode information appears.

```

Command Prompt - telnet
Serial Number 5221484 MAC address 00:20:40:52:53:EC
Software version 004.5 (020318)
Press Enter to go into Setup Mode

*** basic parameters
Hardware: Ethernet Autodetect
IP addr 172.30.1.70, no gateway set,netmask 255.255.000.000

***** Security *****
SNMP is enabled
SNMP Community Name: public
Telnet Setup is enabled
TFTP Download is enabled
Port 77FEh is enabled
Web Server is enabled
Encryption is disabled
Enhanced Password is disabled

***** Channel 1 *****
Baudrate 9600, I/F Mode 4C, Flow 00
Port 10001
Remote IP Addr: none, Port 00000
Connect Mode: C0 Discconn Mode: 00
Flush Mode: 00

***** Channel 2 *****
Baudrate 9600, I/F Mode 4C, Flow 00
Port 10002
Remote IP Addr: none, Port 00000
Connect Mode: C0 Discconn Mode: 00
Flush Mode: 00

***** Expert *****
ICP Keepalive: 45s
ARP cache timeout: 600s

Change Setup : 0 Server configuration
                1 Channel 1 configuration
                2 Channel 2 configuration
                3 Expert settings
                4 Security
                5 Factory defaults
                6 Exit without save
                7 Save and exit
                Your choice ? _
    
```

7. Type **1** and press [ENTER] to set up Channel 1 configuration. This information appears.

```

Telnet - 172.17.10.70
Connect Edit Terminal Help

Change Setup : 0 Server configuration
                1 Channel 1 configuration
                2 Channel 2 configuration
                3 Expert settings
                4 Security
                5 Factory defaults
                6 Exit without save
                7 Save and exit
                Your choice ? 1

Baudrate (09600)
I/F Mode (4C) ?
Flow (00) ?
Port No (07700) ?
ConnectMode (CC) ?
Datagram Type (00) ?
*** basic parameters
Hardware: Ethernet Autodetect
IP addr 172.017.010.070, gateway 255.255.255.000,netmask 255.255.000.000

***** Channel 1 *****
Baudrate 09600, I/F Mode 4C, Flow 00
Port 07700
Datagram Type 00
Pack Cntrl: 00

Change Setup : 0 Server configuration
                1 Channel 1 configuration
                2 Channel 2 configuration
                3 Expert settings
                4 Security
                5 Factory defaults
                6 Exit without save
                7 Save and exit
                Your choice ?
    
```

If the default value displayed in your **Telnet** window does not match the value listed in any of the steps below, type the correct value and press [ENTER].

8. At the **Baud Rate** prompt, press [ENTER] to accept the default (9600).
9. At the **I/F Mode** prompt, press [ENTER] to accept the default (4C).
10. At the **Flow** prompt, press [ENTER] to accept the default (00).
11. Type a unique **Port Number** for the LAN to which the C900V2 is connected and press [ENTER].
12. At the **ConnectMode** prompt, press [ENTER] to accept the default (CC).
13. At the **Datagram Type** prompt, type 01 and press [ENTER].
14. At the **IP addr** prompt, type the remote IP address used for the receiver to which the C900V2 reports and press [ENTER].

Enter the remote IP address using 000.000.000.000 format.

15. Type the **Port Number** for the receiver and press [ENTER].

If you want to enable encryption, continue with the next step. If not, go to step 27.

If you enable encryption on the C900V2, you must enable encryption on the D6680 with the same key.

16. From the **Change Setup** menu, type 6 and press [ENTER].

This information appears.

```

Telnet - 172.30.1.31
Connect Edit Terminal Help

Change Setup : 0 Server configuration
                1 Channel 1 configuration
                2 Channel 2 configuration
                3 Expert settings
                4 Security
                5 Factory defaults
                6 Exit without save
                7 Save and exit
                Your choice ? 6

Disable SNMP (N) N
SNMP Community Name (:):
Disable Telnet Setup (N) N
Disable TFTP Firmware Update (N) N
Disable Port 77FEh (N) N
Disable Web Server (N) N
Disable ECHO ports (Y) Y
Enable Encryption (N)
    
```

17. At the **Disable SNMP** prompt, press [ENTER] to accept the default (N).
18. At the **SNMP Community Name** prompt, press [ENTER] to accept the default (public).
19. At the **Disable Telnet Setup** prompt, press [ENTER] to accept the default (N).
20. At the **Disable Port 77FEh** prompt, press [ENTER] to accept the default (N).

Disabling both the telnet and port 77FE prevents you from accessing the set-up menu for future changes.

21. At the **Disable Web Server** prompt, press [ENTER] to accept the default (N).
22. At the **Disable ECHO ports** prompt, press [ENTER] to accept the default (Y).
23. At the **Enable Encryption** prompt, type y and press [ENTER].
24. At the **Change keys** prompt, type y and press [ENTER].
25. Type the key programmed for the receiver and press [ENTER].

The key is 16 bytes (32 characters) long. Enter the key using the 01-02-03-04-05-06-07-08-09-10-11-12-13-14-15-16 format.

26. At the **Enable Enhanced Password** prompt, press [ENTER] to accept the default (N).
27. Type 9 and press [ENTER] to save changes and exit the telnet session.

To confirm that the IP address is configured properly, use the ping utility:

28. At the **C:\>** prompt, type ping <IP Address> and press [ENTER].

Four reply messages are received, confirming the C900V2 is communicating on the network.

Configuration of the C900V2 is complete.

5.0 Anti-Substitution Protection

1. Remove power from the C900V2.
2. Set DIP Switch 9 to the ON position (the factory default). Refer to *Section 3.2 Setting the DIP Switches* on page 8.
3. Apply power to the C900V2.

After rebooting the C900V2, the unit exchanges numeric keys with the receiver, and they become synchronized. Once they are synchronized, all subsequent communications sessions numerically validate the authenticity of the sender and receiver. Each session generates an entirely new set of keys, which invalidates the replay of authentic sessions.

6.0 UL Standard 1610 and ULC S304 Intrusion System Installations

To install the C900V2 to comply with UL Standard 1610 Applications (for Line Security, formerly “Grade AA”) and ULC S304, you must satisfy all requirements in this section.

6.1 Protected Premises Control Panel without Digital Dialer Backup

1. Use the D6200 Software to set the poll rate on the C900V2. For UL approved installations, the maximum interval is 90 seconds to meet the requirement for polling supervision established by UL. In most cases, to get a polling supervision interval of 90 seconds, set the Poll Rate to 75 and Retry to 13.

Because of differences in packet transmission time latency within different networks, the poll rate times vary. Contact Technical Support at Bosch Security Systems, Inc. for assistance in establishing the latency time for the network on which you are installing the C900V2.



Refer to *D6200 Software Operation and Installation Guide* (P/N: 4998154991).

2. Set DIP Switch 7 to the OFF position to enable 75-second supervision signals (the factory default).



Refer to *Table 5* on page 10 for the functions of DIP Switches 5 through 9.

3. Add a telnet password to the communications protocol of the C900V2 (refer to *Section 4.5.3 Configuration Using Telnet*, step 6, on page 16). Retain this password for future reference.
4. Program the control panel to send a daily test signal through the digital dialer.



This tests the connection from the control panel to the C900V2.

5. Connect Output 1 from the C900V2 to a 24-hour zone on the control panel.



This enables the control panel to locally announce a C900V2 CPU failure.

6. Connect Output 2 from the C900V2 to a 24-hour zone on the control panel.



This enables the control panel to locally announce a network failure.

You must use the C900V2 with a UL Listed Burglary Alarm Control Unit or a UL Listed combination Fire/Burglary Alarm Control Unit with an integral or Listed digital alarm communicator transmitter (DACT) installed according to the manufacturer’s instructions.

7. Install a tamper switch (such as a D110 Tamper Switch, available from Bosch Security Systems, Inc.) on the control panel enclosure and connect it to a 24-hour zone on the control panel. If you use a separate enclosure for the C900V2, install another tamper switch (D110) on the enclosure and connect it to the same 24-hour zone.
8. Set DIP Switch 5 to OFF to disable Auto Fallback.
9. Set DIP Switch 6 to ON to prevent fallback caused by hang-ups.



Intercept errors are reported to the receiver. If the receiver does not acknowledge a signal sent that was intercepted by the C900V2 in the programmed time, the control panel digital dialer hangs up and retries the message transmission.

10. Set DIP Switch 9 to ON to enable Anti-Substitution/Anti-Replay.
11. Set the shorting link on P3 to the H position.
Refer to *Figure 12* on page 20 and *Table 10* on page 21 for the proper connection sequence.

Figure 12: C900V2 and Generic Control Panel in Separate Enclosures (UL Standard 1610, with or without Telephone Line)

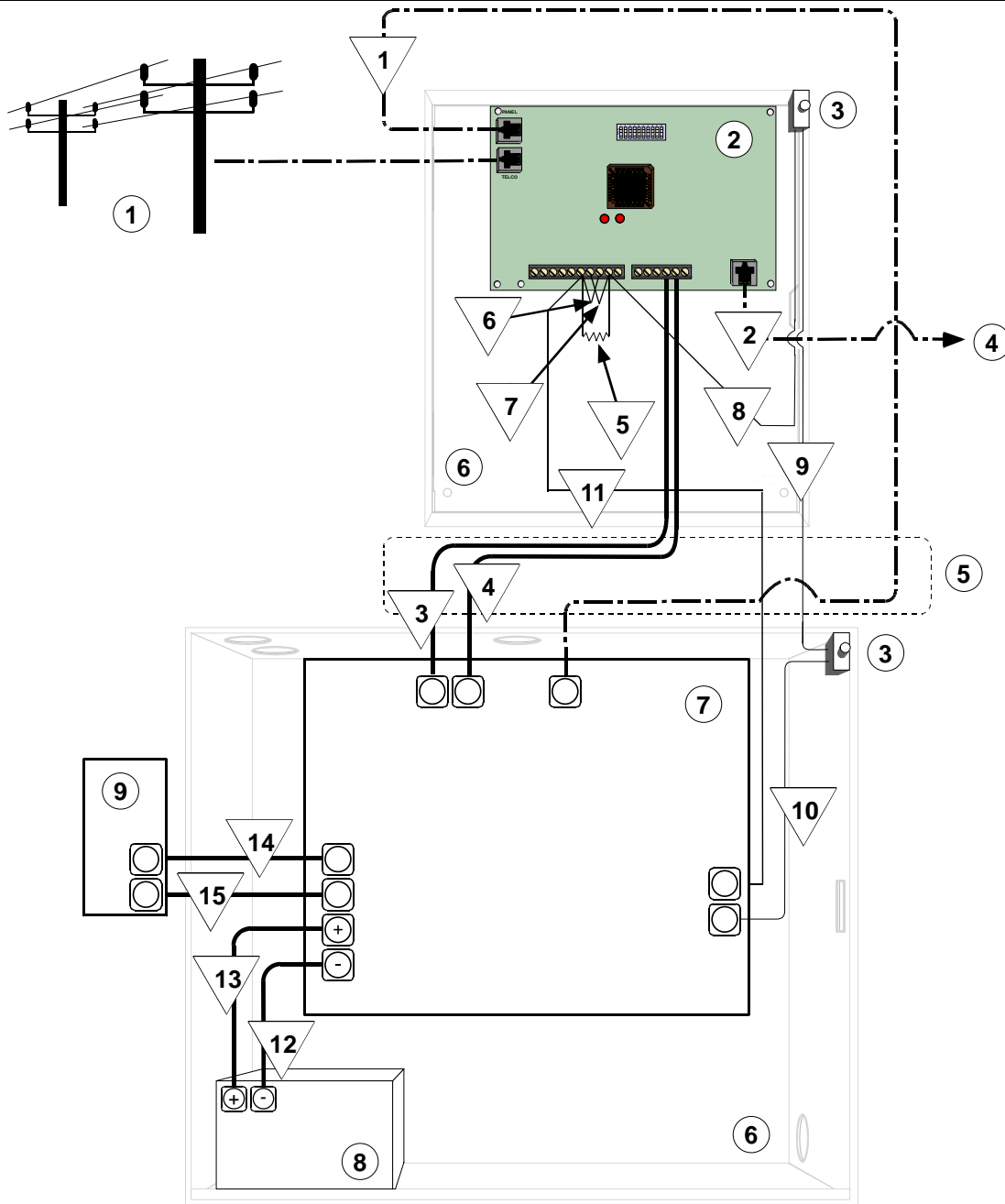

1 – Optional telephone line

2 – C900V2

3 – D110 Tamper Switch

4 – LAN or WAN

5 – Metal conduit no longer than 6.1 m (20 ft)

6 – AE2 enclosure

7 – Host control panel

8 – Battery

9 – AC transformer

▽ indicates the connection sequence. Refer to Table 10.

Table 10: Connection Sequence – C900V2 and Generic Control Panel in Separate Enclosures (UL Standard 1610, with or without Telephone Line)

Seq	C900V2 Connection	Control Panel Connection	Other Connection	
1	RJ-45 PANEL connector	to	RJ-45 connector (telco dialer)	
2	RJ-45 ETHERNET connector	to	LAN or WAN	
3	- V terminal	to	-12 to -24 VDC (common)	
4	V +	to	+12 to +24 VDC output	
5	Install an EOL resistor for the control panel across OUT2-L and OUT1-R			
6	OUT2-L TO OUT1-L			
7	OUT2-R TO OUT1-R			
8	OUT1-R	to	C900V2 enclosure closed-circuit tamper switch	
9			C900V2 enclosure closed-circuit tamper switch to control panel enclosure closed-circuit tamper switch	
10		24-hour zone input common	to	Control panel enclosure closed-circuit tamper switch
11	OUT2-L	to	24-hour zone input	
12		Battery negative input	to	Battery negative terminal
13		Battery positive input	to	Battery positive terminal
14		AC input		AC transformer
15		AC input		AC transformer

NOTE: The sequence numbers appear in the diagram in *Figure 12*.



The optional telephone line is for programming and diagnostics only.

6.2 Protected Premises Control Panel with Digital Dialer Backup

1. Use the D6200 Software to set the poll rate on the C900V2. For UL approved installations, the maximum interval is 360 seconds to meet the requirement for polling supervision established by UL. In most cases, to get a polling supervision interval of 360 seconds, set the Poll Rate to 240 and Retry to 13.

Because of differences in packet transmission time latency within different networks, the poll rate times vary. Contact Technical Support at Bosch Security Systems, Inc. for assistance in establishing the latency time for the network on which you are installing the C900V2.



Refer to *D6200 Software Operation and Installation Guide* (P/N: 4998154991).

2. Set DIP Switch 7 to the ON position to enable 240-second supervision signals.



Refer to *Table 5* on page 10 for the functions of DIP Switches 5 through 9.

3. Add a telnet password to the communications protocol of the C900V2 (refer to *Section 4.5.3 Configuration Using Telnet*, step 6, on page 16). Retain this password for future reference.
4. Program the control panel to send a daily test signal through the digital dialer.



This tests the connection from the control panel to the C900V2.

5. Connect Output 1 from the C900V2 to a 24-hour zone on the control panel.



This tests the digital dialer if the C900V2 CPU fails.

6. Connect Output 2 from the C900V2 to a 24-hour zone on the control panel.



This tests the digital dialer if the network communications path supervision fails.

You must use the C900V2 with a UL Listed Burglary Alarm Control Unit or a UL Listed combination Fire/Burglary Alarm Control Unit with an integral or Listed digital alarm communicator transmitter (DACT) installed according to the manufacturer's instructions.

7. Install a tamper switch (such as a D110 Tamper Switch, available from Bosch Security Systems, Inc.) on the control panel enclosure and connect it to a 24-hour zone on the control panel. If you use a separate enclosure for the C900V2, install another tamper switch (D110) on the enclosure and connect it to the same 24-hour zone.
8. Set DIP Switch 5 to ON to enable Auto Fallback.
9. Set DIP Switch 6 to OFF so three hang-ups cause fallback.



Any error forces the C900V2 to switch to Fallback Mode for 2 minutes the next time the alarm panel seizes the line (if DIP Switch 5 is ON or DIP Switch 6 is OFF, or both, and the seizure occurs within 2 minutes). Intercept errors are always reported to the receiver. If the receiver does not acknowledge the signal in the programmed time, the control panel digital dialer hangs up and retries the message.

10. Set DIP Switch 9 to ON to enable Anti-Substitution/Anti-Replay.
11. Set the shorting link on P3 to the H position. Refer to *Figure 12* on page 20 and *Table 10* on page 21 for the proper connection sequence.

7.0 UL Standard 864 for Fire System Installations

To install the C900V2 in compliance with UL 864 for Fire System Installations, you must satisfy all requirements in this section. You must install the system in accordance with NFPA-72.

If the control panels are used for fire applications, test according to NFPA-72.



For UL Listed Fire Installations, shared on-premises communications equipment must be UL Listed for Information Technology Equipment.

Installation at the Protected Premises

1. Use the D6200 Software to set the poll rate on the C900V2. For UL approved installations, the maximum interval is 90 seconds to meet the requirement for polling supervision established by UL. In most cases, to get a polling supervision interval of 90 seconds, set the Poll Rate to 75 and Retry to 13.

(For non-UL approved installations, the maximum interval is 300 seconds to meet the requirement for polling supervision set by NFPA Standard 72, Section 5-5.4.4.1. To get a polling supervision interval of 300 seconds, set the Poll Rate to 240 and Retry to 13.)

Because of differences in packet transmission time latency within different networks, the poll rate times vary. Contact Technical Support at Bosch Security Systems, Inc. for help in establishing the latency time for the network on which you are installing the C900V2.



Refer to *D6200 Software Operation and Installation Guide* (P/N: 4998154991).

2. Set DIP Switch 7 to the OFF position to enable 75-second supervision signals.



Refer to *Table 5* on page 10 for the functions of DIP Switches 5 through 9.

3. Add a telnet password to the communications protocol of the C900V2 (refer to *Section 4.5.3 Configuration Using Telnet*, step 6, on page 16). Retain the password for future reference.

4. Program the control panel to send a daily test signal through the digital dialer.



This tests the connection from the control panel to the C900V2.

5. Connect Output 1 from the C900V2 to a 24-hour zone on the control panel.



This enables the control panel to annunciate a C900V2 CPU failure locally.

6. Connect Output 2 from the C900V2 to a 24-hour zone on the control panel.



This enables the control panel to annunciate a network failure locally.

You must use the C900V2 with a UL Listed Fire Alarm Control Unit or a UL Listed combination Fire/Burglary Alarm Control Unit with an integral or UL Listed digital alarm communicator transmitter (DACT). Refer to the *C900TTL-E and C900V2 Compatibility Chart* (P/N: 4998141056).

7. If the C900V2 is installed in a separate enclosure, you must locate the unit in the same room within 6.1 m (20 ft) because the control equipment and the wiring must be enclosed in conduit (or equivalently protected against mechanical injury).



Mounting a C900V2 in a control panel enclosure is approved by UL only when used with a DS 7400Xi as shown in *Figure 5* on page 6.

8. You must use the C900V2 with a UL Listed Power Supply (such as Altronix® AL300-ULXR).
9. Set DIP Switch 5 to OFF to disable Auto Fallback.
10. Set DIP Switch 6 to ON to prevent fallback caused hang-ups.



Intercept errors are reported to the receiver. If the receiver does not acknowledge a signal sent that was intercepted by the C900V2 in the programmed time, the control panel digital dialer hangs up and retries the message transmission.

11. Set DIP Switch 9 to ON to enable Anti-Substitution/Anti-Replay.
12. Set the shorting link on P3 to the H position. Refer to *Figure 13* on page 24 and *Table 11* on page 25 for the proper connection sequence.

Figure 13: C900V2 and Generic Control Panel in Separate Enclosures (UL Standard 864)

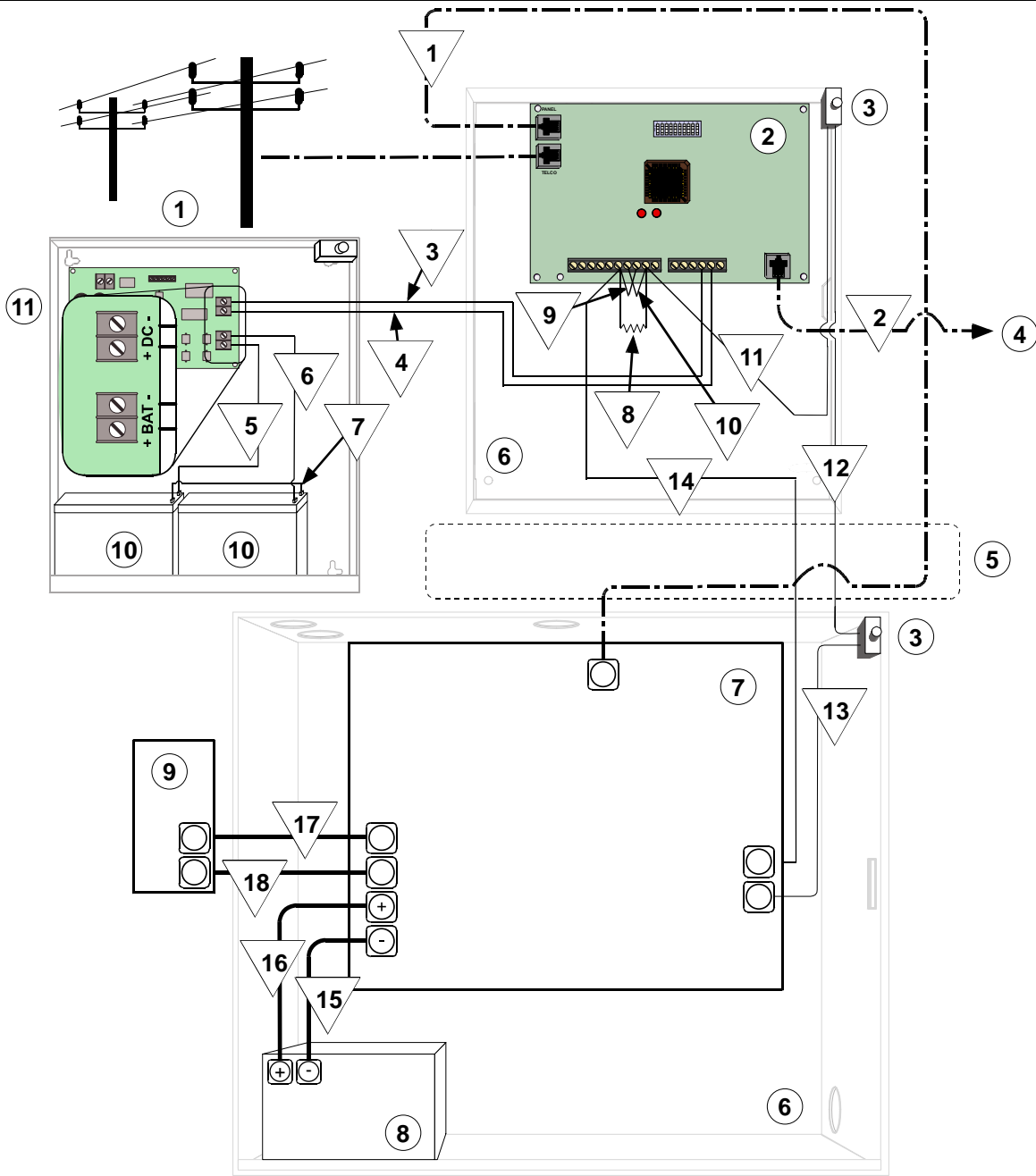

1 – Optional telephone line

2 – C900V2

3 – D110 Tamper Switch

4 – LAN or WAN

5 – Metal conduit no longer than 6.1 m (20 ft)

6 – AE2 enclosure

7 – Host control panel

8 – Battery

9 – AC transformer

10 – Battery

11 – UL Listed power supply (such as Altronix AL300-ULXR) in separate enclosure

▽ indicates the connection sequence. Refer to Table 11.

Table 11: Connection Sequence – C900V2 and Generic Control Panel in Separate Enclosures (UL Standard 864)

Seq	C900V2 Connection	Control Panel Connection	Other Connection
1	RJ-45 PANEL connector to	RJ-45 connector (telco dialer)	
2	RJ-45 ETHERNET connector to		LAN or WAN
3	- V terminal to		-12 to -24 VDC (common)
4	V + to		+12 to +24 VDC output
5			Power supply +BAT input to battery 1 + terminal
6			Power supply -BAT input to battery 2 - terminal
7			Battery 1 - terminal to battery 2 + terminal (in series)
8	Install an EOL resistor for the control panel across OUT2-L and OUT1-R		
9	OUT2-L to OUT1-L		
10	OUT2-R to OUT1-R		
11	OUT1-R to		C900V2 enclosure closed-circuit tamper switch
12			C900V2 enclosure closed-circuit tamper switch to control panel enclosure closed-circuit tamper switch
13		24-hour zone input common to	Control panel enclosure closed-circuit tamper switch
14	OUT2-L to	24-hour zone input	
15		Battery negative input to	Battery negative terminal
16		Battery positive input to	Battery positive terminal
17		AC input	AC transformer
18		AC input	AC transformer

NOTE: The sequence numbers appear in the diagram in *Figure 13*.

8.0 Specifications

Table 12: Specifications	
Voltage Range	12 VDC to 24 VDC, nominal
Current	280 mA, maximum
Dimensions	17.8 cm x 11.4 cm (7 in. X 4.5 in.)
Operating Temperature	0° C to 49° C (32° F to 120° F)
Connectors:	
Control Panel	RJ-45 modular jack
Telco	RJ-45 modular jack
LAN/WAN	RJ-45 modular jack
Ethernet Cable	Category 3 or better (10 Base-T) or Category 5 or better (100 Base-T), unshielded twisted pair, 100 m (328 ft) maximum
Input Protocol (from control panel)	Refer to <i>Table 4</i> on page 9.
Output Protocol (to LAN/WAN)	UDP/IP packets
Ringer Equivalency Number	0.0 B
Interface	IEEE 802.3
Outputs	Relay contact type

Appendix : C900V2 Compatible Data Formats

Table 13: Compatible Central Station Receiver Formats									
Receiver Model	Compatible Receiver Formats								
	Radionics Modem I, II and IIIa ²	Radionics BFSK	SIA Bell 103, 110 & 300 baud	Pulse			DTMF		
				3/1	3/1 Checksum	4/2	Contact ID	Ademco High Speed	Ademco 4/2 Express
D6600	X	X	X	X	X	X	X	X	X
D6100i	X	X	X	X	X	X	X	X	X

Bosch Security Systems, Inc.
130 Perinton Parkway
Fairport, NY 14450-9199
(800) 289-0096

© 2008 Bosch Security Systems, Inc.
F01U087780-01



BOSCH